

# ZOOM 信隆 專用

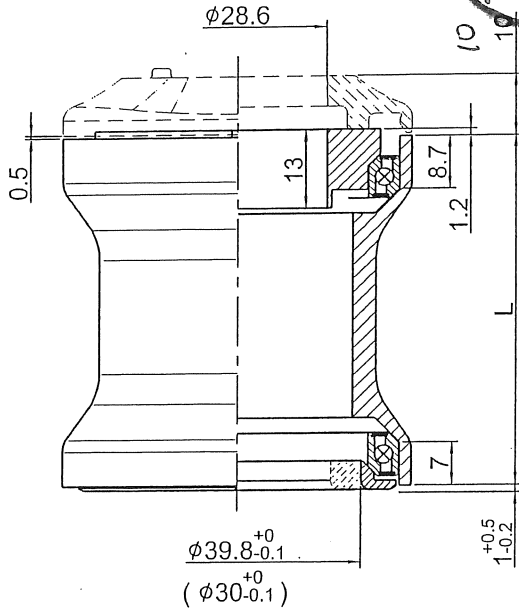

Stack Hight=10+1=11±0.5

客供品

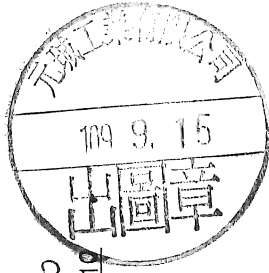
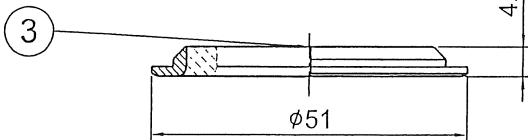
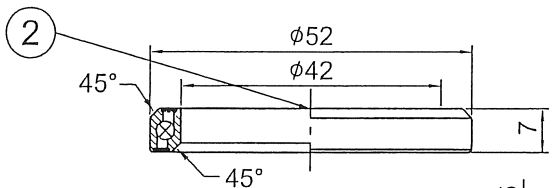
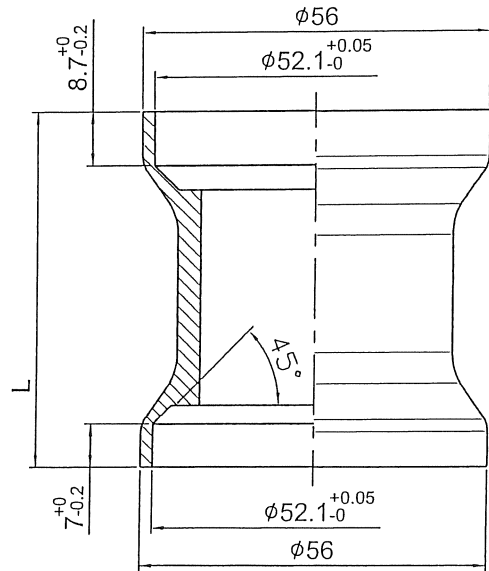
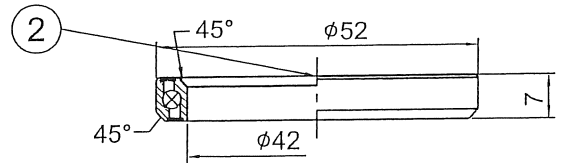
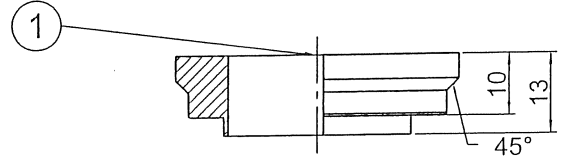
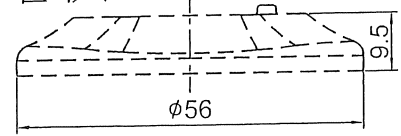

型號 (Model No)	零件料號 (Item No)	尺寸 (Dimension)
PT-1864B-1-078	H6420-1	$\phi D^{+0}_{-0.1}$
PT-1864B-2-078	H6421-1	$\phi 39.8^{+0}_{-0.1}$
		$\phi 30.0^{+0}_{-0.1}$

NO	零件名稱 (Item Name)	零件料號 (Item No)	材質 (Material)	數量 (Qty)	
	客供上蓋(穿線)	TOP COVER			
* 1	束環(穿線)上8.7用	COMPRESSION RING	H2872B	Nylon	1PCS
2	軸承 (52X42X45x7)	SEALED BEARING	R457B	SUJ2	2PCS
* 3	鋁下塞	CROWN RACE	AL7075	1PCS	

4	PT-1864B-078 ZOOM				上8.7 下7.0	名稱	
3	繪圖DRAWN BY		日期 DATE		校對 CHKCKED BY	圖號	
2	林美紅		1090428			單位	mm
1	設計DESIGNED BY		日期 DATE			比例 SCALE	1:1
編號 NO	原有資料	修改資料	更改者 BY	日期 DATE	109.5.8		
PRESTINE						元城工業有限公司	