

# ZOOM 信隆 專用

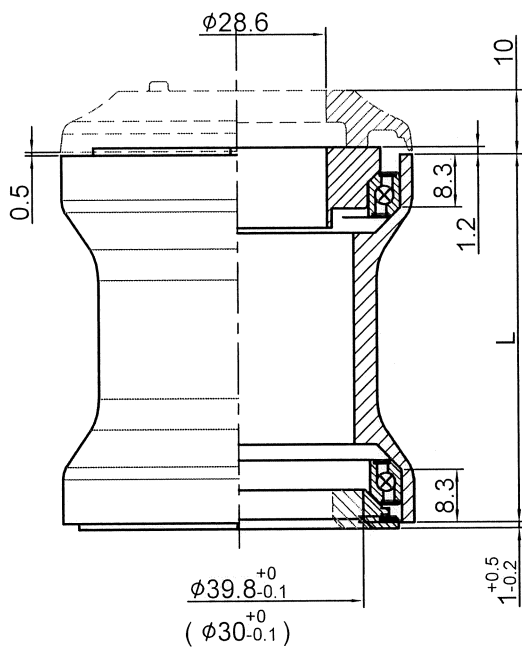

Stack Height=10+1=11±0.5

型號 (Model No)	零件料號 (Item No)	$\phi D^{+0}_{-0.1}$
PT-1865A-1-078	H6430-1	$\phi 39.8^{+0}_{-0.1}$
PT-1865A-2-078	H6430-2	$\phi 30.0^{+0}_{-0.1}$

NO	零件名稱 (Item Name)	零件料號 (Item No)	材質 (Material)	數量 (Qty)	
	客供上蓋 (穿線)	TOP COVER			
* 1	束環 (穿線) 上8.3用	COMPRESSION RING	H2877A	AL6061	1PCS
2	軸承 (52X42X45°x7)	SEALED BEARING	R457B	SUJ-2	2PCS
3	防水圈	SEAL	A277	Rubber	1PCS
* 4	1.5"鋁下塞 (下8.3用)	CROWN RACE		AL7075	1PCS

客供品

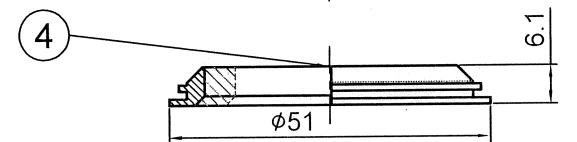
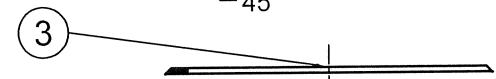
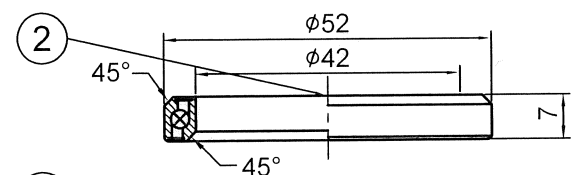
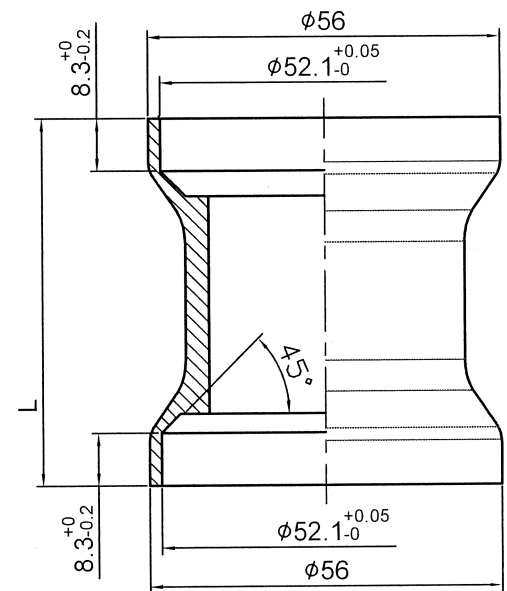
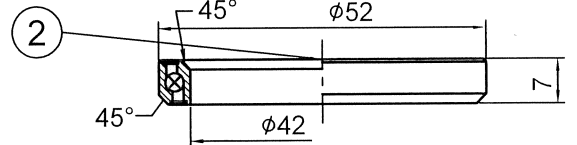
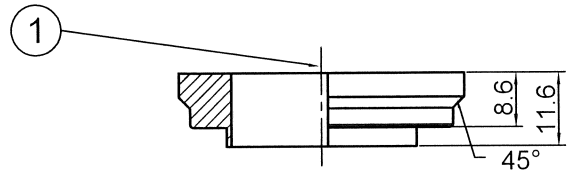
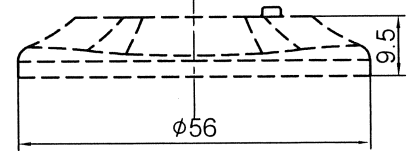

編號 NO				修改資料		更改者 BY		日期 DATE		PT-1865A-078 ZOOM		名稱		
4										上8.3 下8.3				
3														
2														
1														
										繪圖 DRAWN BY	日期 DATE	校對 CHECKED BY	圖號	
										陳婉儒	1110628			
										設計 DESIGNED BY	日期 DATE	陳勝松	單位	
												11.12.9	mm	
<b>PRESTINE</b>										元城工業有限公司			比例 SCALE	1:1